

# End of Year Booklet



# My School



My school is called \_\_\_\_\_

\_\_\_\_\_

It is a school for \_\_\_\_\_

It is in \_\_\_\_\_

The principal is called \_\_\_\_\_

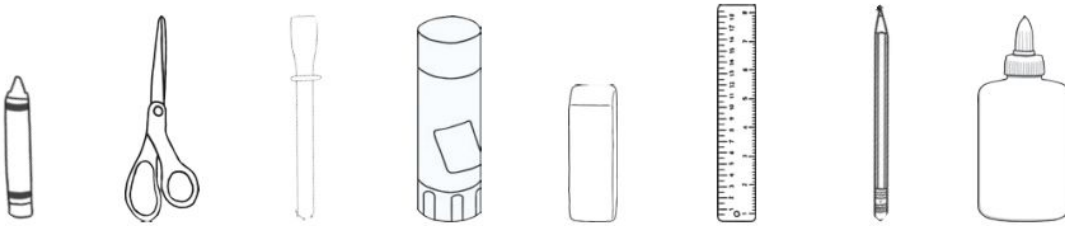

# My Teacher

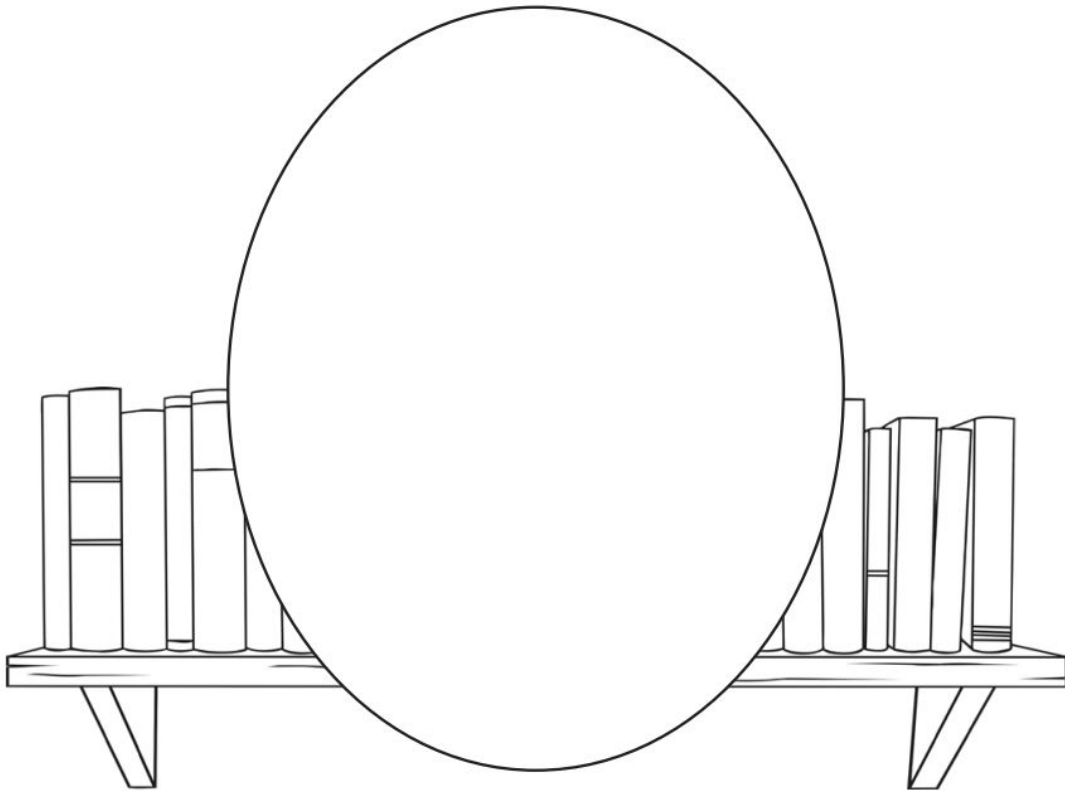

My teacher is called \_\_\_\_\_

He/she is \_\_\_\_\_ and \_\_\_\_\_

He/she has \_\_\_\_\_ and \_\_\_\_\_

I like my teacher because \_\_\_\_\_

\_\_\_\_\_

\_\_\_\_\_

\_\_\_\_\_

# My Friends



I have lots of friends in school.

My friends are \_\_\_\_\_ and \_\_\_\_\_

We like to \_\_\_\_\_  
\_\_\_\_\_ together.

# What I Like About School



My favourite thing about school this year was

---

---

I liked how we always

---

---

---

# Next Year!

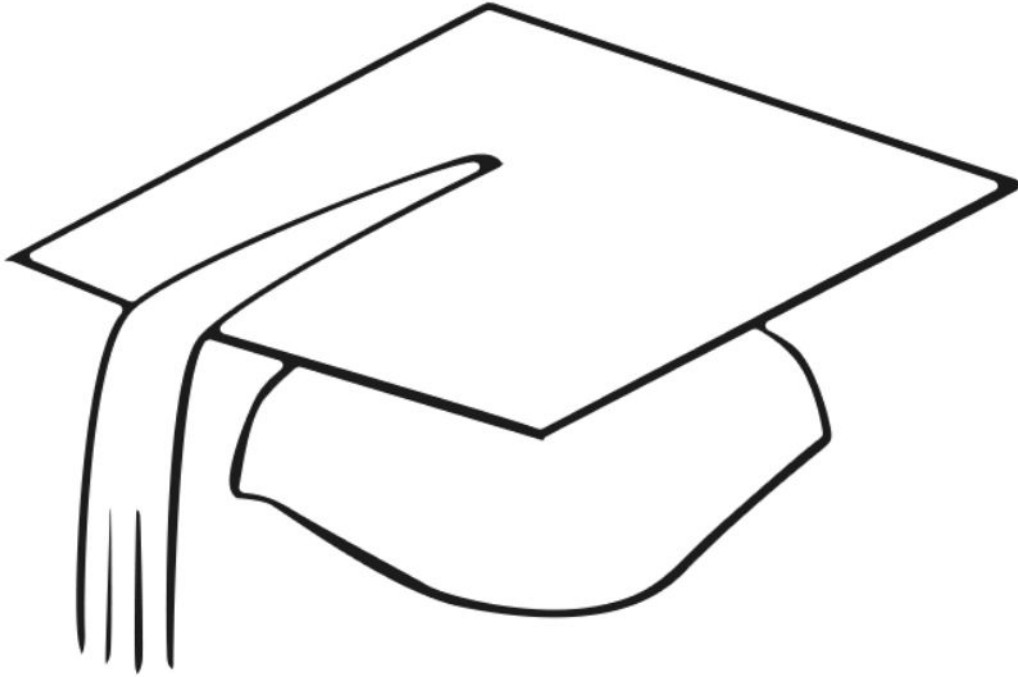

Next year, I will be in \_\_\_\_\_

I am looking forward to \_\_\_\_\_







I will have a new teacher called \_\_\_\_\_

Next year will be different because \_\_\_\_\_

\_\_\_\_\_  
\_\_\_\_\_

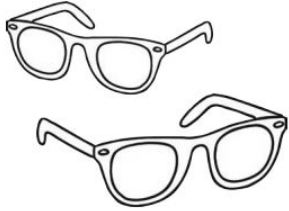
# Read and Colour

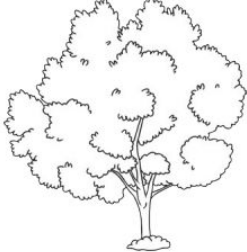
Read the sentence in each box and colour the picture to match the sentence.

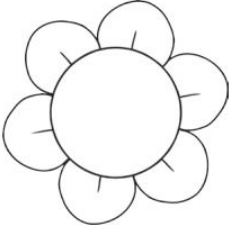
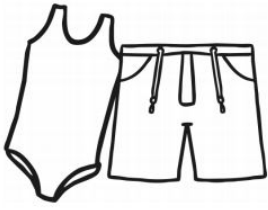
<p>1.</p>  <p>The bucket is red. The spade is yellow.</p>	<p>2.</p>  <p>The sun is yellow.</p>	<p>3.</p>  <p>The top sunglasses are blue. The bottom sunglasses are pink.</p>
<p>4.</p>  <p>The flip-flops are green and orange.</p>	<p>5.</p>  <p>The kite is blue, yellow, green and red.</p>	<p>6.</p>  <p>The leaves are green. The bark is brown.</p>
<p>7.</p>  <p>The first lolly is orange. The second lolly is blue. The third lolly is red.</p>	<p>8.</p>  <p>The flower is pink.</p>	<p>9.</p>  <p>The swimming costume is purple. The swimming shorts are green.</p>



# Summer



a b c b e a c h i i k s  
t n o p q r h o t c w w  
s l o l l y e l g e i i  
h i m n o p q i s c u m  
i c y z a b c d e r g s  
r s u m m e r a q e s u  
t c w a r m a y s a e i  
g r i j k l m n h m q t  
s e u v w x y z o b c y  
e s u n n y k l r n o p  
q m s t u v w x t z a b  
s s u n g l a s s e s n

beach  
holiday  
hot  
ice cream



lolly  
shorts  
summer  
sunglasses

sunny  
swimsuit  
t-shirt  
warm

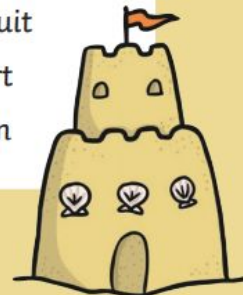







# 2D Shape Hunt

Count and colour the 2D shapes hidden in this summer scene.



			
			

# Summer Sunglasses

In each lens of the sunglasses, draw two different pictures of something you saw or did during your summer.

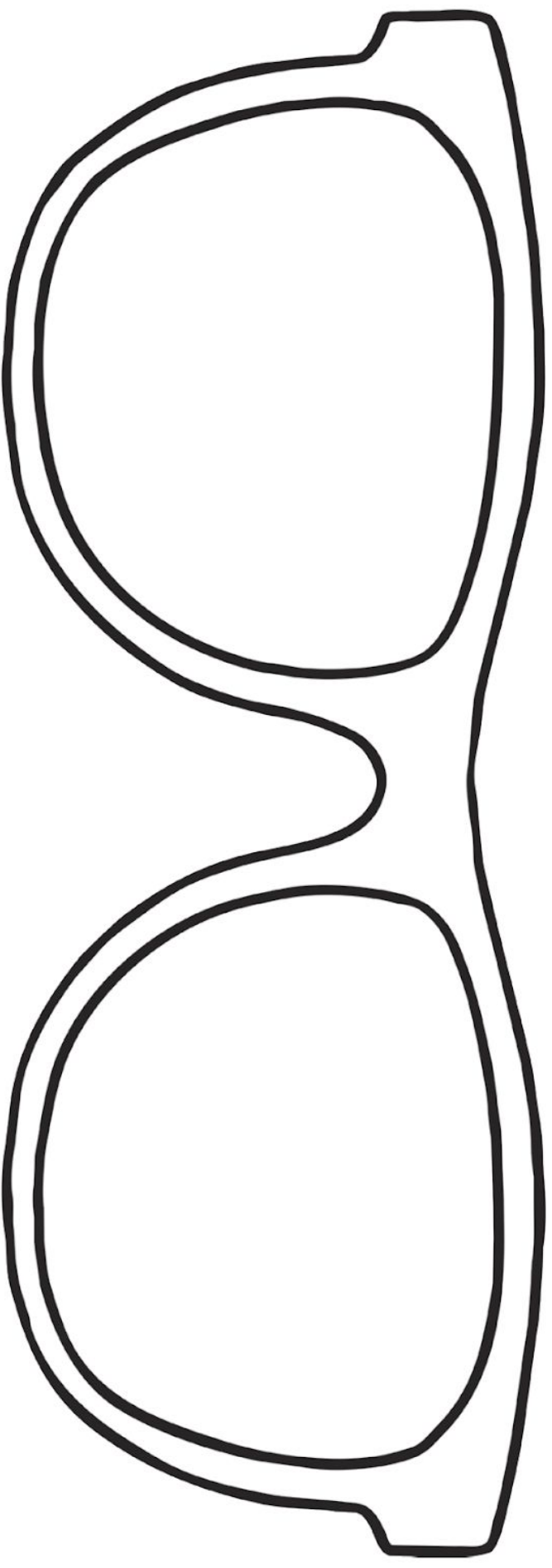

# Summer Dot-to-Dot

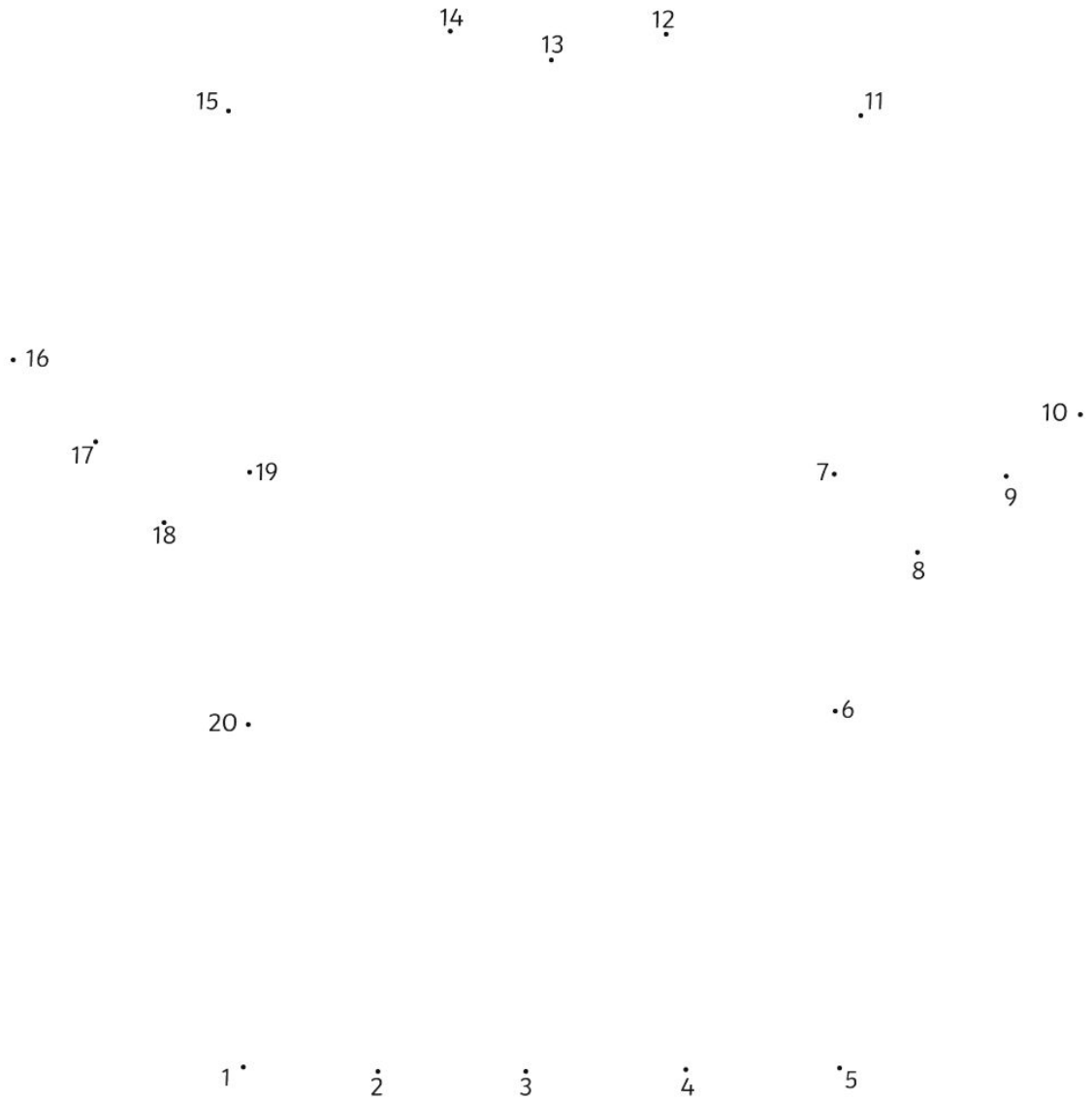

# Summer Dot-to-Dot

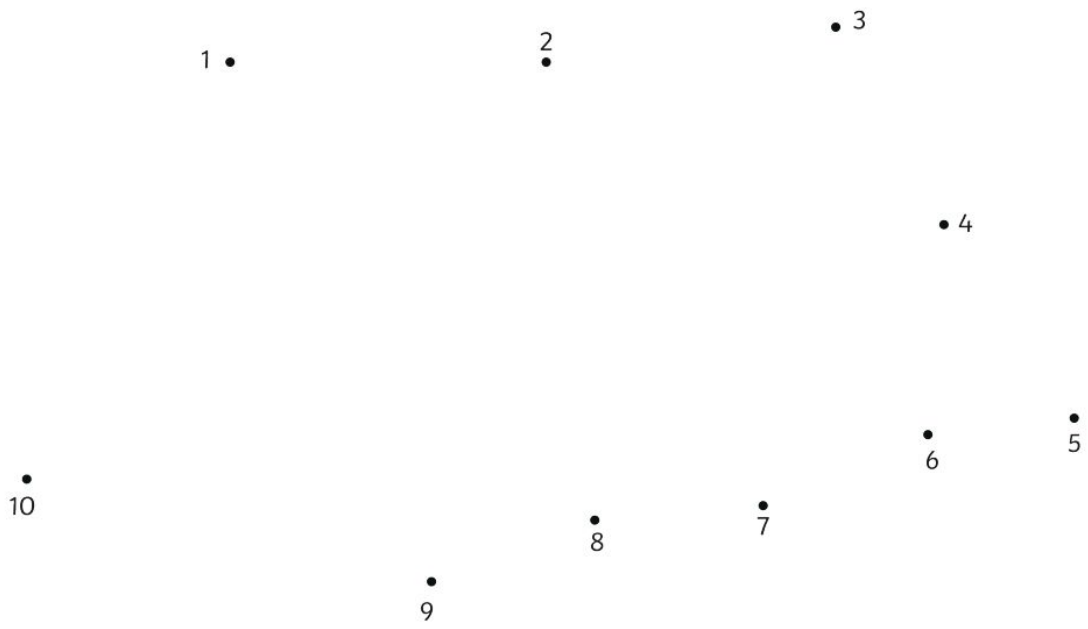

# Summer

Match the colours to the numbers.

- 1 = red
- 2 = orange
- 3 = yellow
- 4 = green
- 5 = blue
- 6 = purple
- 7 = pink

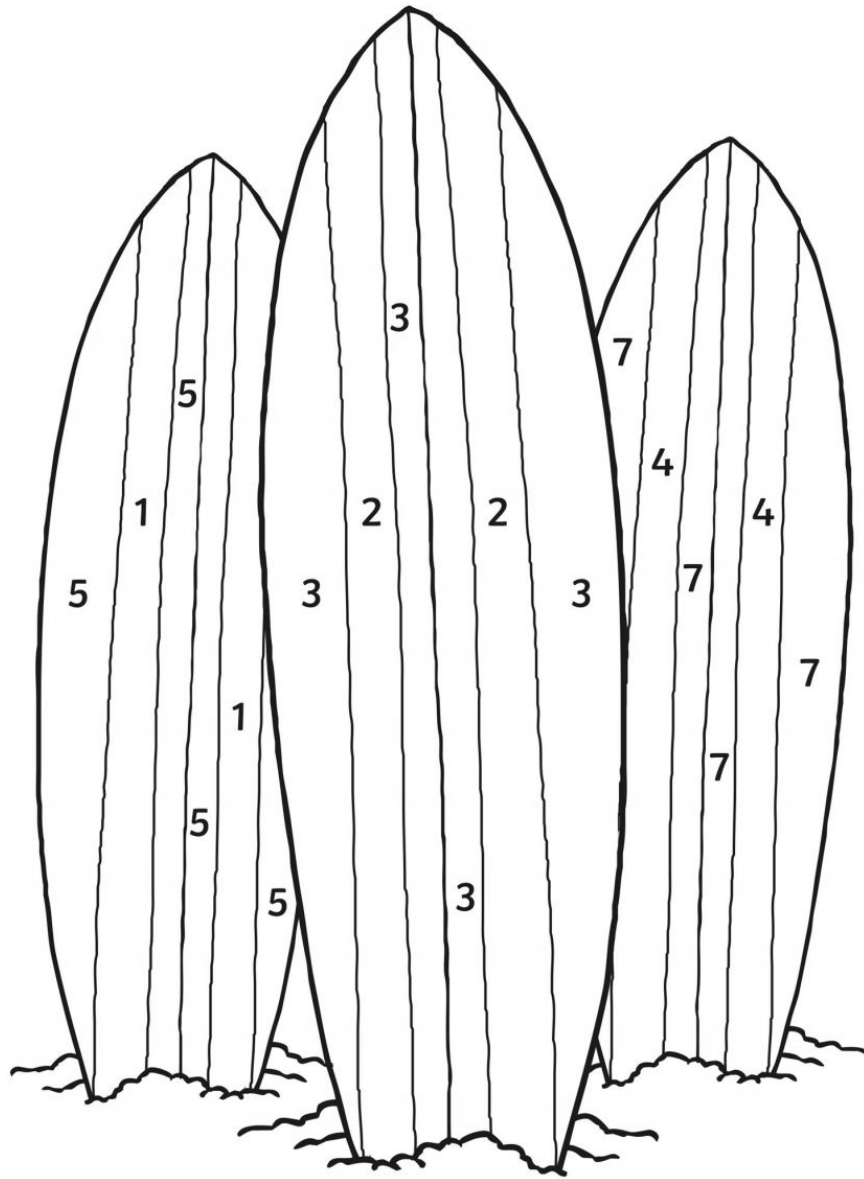







# Addition and Subtraction to 20

## Colour by Number

Solve the calculations to colour in this summer picture.

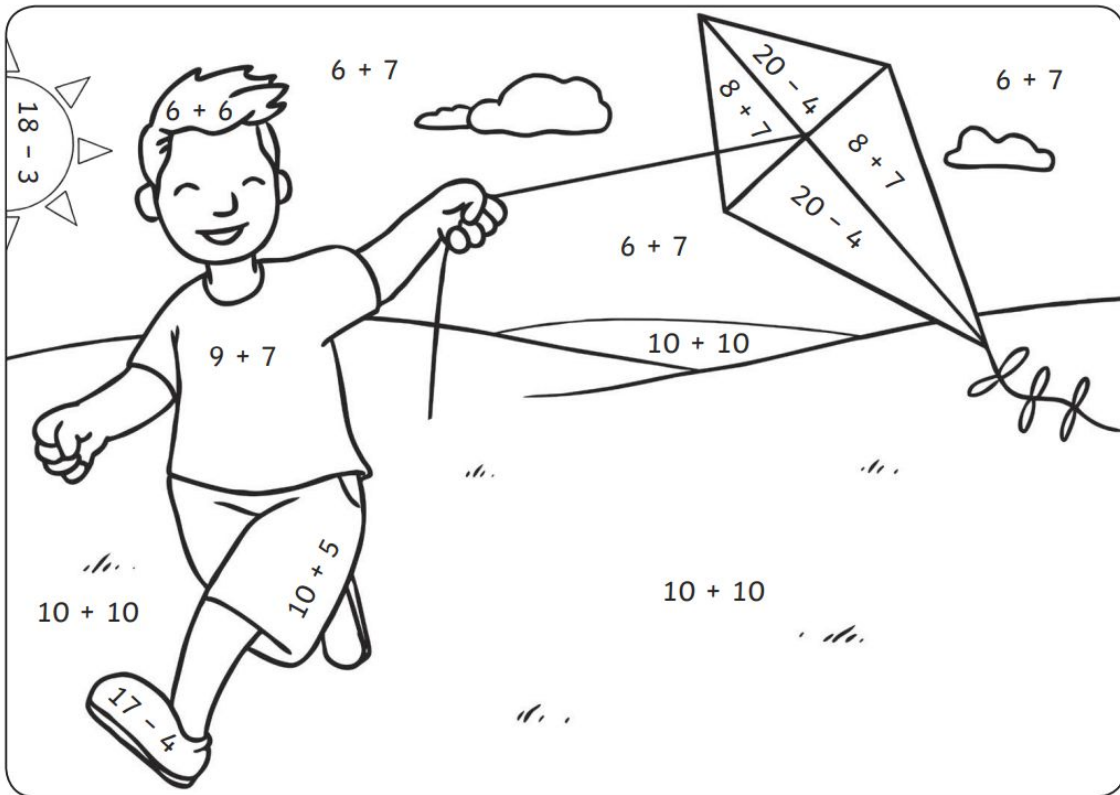

<b>Answer:</b>	<b>16</b>	<b>15</b>	<b>20</b>	<b>12</b>	<b>13</b>
<b>Colour:</b>	red	yellow	green	brown	blue

# Addition and Subtraction to 20

## Summer Mosaic

Solve the calculations to reveal the hidden picture. Each answer has a special colour.

yellow = 0-8

pink = 9-15

brown = 16-20

						$17 - 1$	
			$19 - 4$	$9 + 6$		$17 + 2$	
		$10 - 1$	$6 + 5$	$19 - 10$	$12 + 2$	$18 - 2$	
	$15 - 4$	$12 + 3$	$18 - 9$	$11 + 2$	$17 - 2$	$5 + 8$	
	$20 - 20$	$5 + 2$	$17 - 9$	$2 + 6$	$2 - 1$	$2 + 2$	
	$9 - 1$	$8 + 0$	$10 - 2$	$1 + 6$	$18 - 10$	$4 + 3$	
		$14 - 7$	$6 - 3$	$3 + 2$	$5 + 2$		
			$7 - 4$	$20 - 12$			
			$5 + 1$	$2 + 6$			

**Challenge:** You have 5 ice creams. You eat 2. How many do you have left? Write this problem as a calculation.

# Summer Addition Mosaic

Solve the maths problems to reveal the hidden picture. Each answer has a special colour:

7, 2 – **pink**

1, 9 – **yellow**

4, 5, 6, 8 and 10 – **blue**

0, 3 – **green**

$1+4$	$9+1$	$10+0$	$7+3$	$1+4$	$9+1$	$10+0$	$7+3$	$7+1$	$1+7$
$2+8$	$1+5$	$1+1$	$0+7$	$8+2$	$6+2$	$5+2$	$3+4$	$2+3$	$6+4$
$2+6$	$5+5$	$1+6$	$7+0$	$6+1$	$2+5$	$2+0$	$0+2$	$3+5$	$1+3$
$1+4$	$9+1$	$10+0$	$0+2$	$1+0$	$5+4$	$5+2$	$4+0$	$8+0$	$6+0$
$0+10$	$0+4$	$4+4$	$5+2$	$7+2$	$0+1$	$3+4$	$5+0$	$2+2$	$0+4$
$0+8$	$3+3$	$5+2$	$3+4$	$6+1$	$2+5$	$1+1$	$0+7$	$0+6$	$10+0$
$9+1$	$0+0$	$4+3$	$0+2$	$1+2$	$0+3$	$1+6$	$7+0$	$3+0$	$9+1$
$8+0$	$6+0$	$2+1$	$3+5$	$1+2$	$2+1$	$1+4$	$0+3$	$0+10$	$0+4$
$4+0$	$8+0$	$6+0$	$3+0$	$0+3$	$3+0$	$0+0$	$0+10$	$0+4$	$4+4$
$1+4$	$9+1$	$10+0$	$7+3$	$2+1$	$1+2$	$1+4$	$9+1$	$10+0$	$7+3$

# Summer Addition Mosaic

Solve the maths problems to reveal the hidden picture. Each answer has a special colour:

11, 12, 13, 14, 15, 16 – **brown**

17, 18, 19 – **orange**

6, 7, 8, 9 – **yellow**

0, 1, 2, 3, 4, 5 – **green**

10, 20 – **blue**

$11+9$	$3+17$	$1+9$	$12+8$	$10+7$	$9+9$	$8+12$	$9+1$	$2+18$	$17+3$
$18+2$	$13+7$	$4+6$	$9+8$	$9+10$	$12+6$	$13+6$	$6+14$	$20+0$	$8+2$
$2+8$	$5+15$	$9+11$	$0+0$	$14+5$	$11+6$	$0+6$	$3+7$	$4+16$	$1+19$
$7+13$	$14+6$	$0+1$	$2+0$	$3+2$	$3+3$	$2+4$	$1+5$	$7+3$	$16+4$
$6+4$	$3+1$	$2+2$	$2+1$	$2+3$	$2+5$	$4+3$	$4+4$	$2+6$	$19+1$
$5+5$	$0+11$	$10+1$	$6+6$	$4+9$	$9+3$	$5+7$	$9+5$	$8+4$	$0+10$
$10+0$	$2+18$	$6+5$	$5+6$	$3+9$	$7+8$	$7+4$	$7+7$	$20+0$	$8+12$
$9+1$	$2+18$	$17+3$	$2+10$	$7+6$	$4+7$	$8+8$	$11+9$	$3+17$	$1+9$
$6+14$	$20+0$	$8+2$	$19+1$	$4+8$	$0+13$	$6+4$	$18+2$	$13+7$	$4+6$
$3+7$	$4+16$	$1+19$	$0+10$	$7+5$	$5+6$	$5+5$	$2+8$	$5+15$	$9+11$

# End of School Year

s o n m o o r s s a l c  
m u m a e r c e c i y o  
y l m b i t e b y a g u  
a i v m r e t o o e a r  
f e w o e t n o f r b k  
u m e t h r i t s o l r  
v i a t c h p c i p o o  
d t t i a a e l t l o w  
g d h a e t e o s a h e  
i r e w t s l s h n c m  
c a r t e w s e i e s o  
a y n o s y a d i l o h

holidays

summer

closed

homework

teacher

classroom

yard time

aeroplane

weather

ice cream

sleep-in

schoolbag



# School Holidays

